

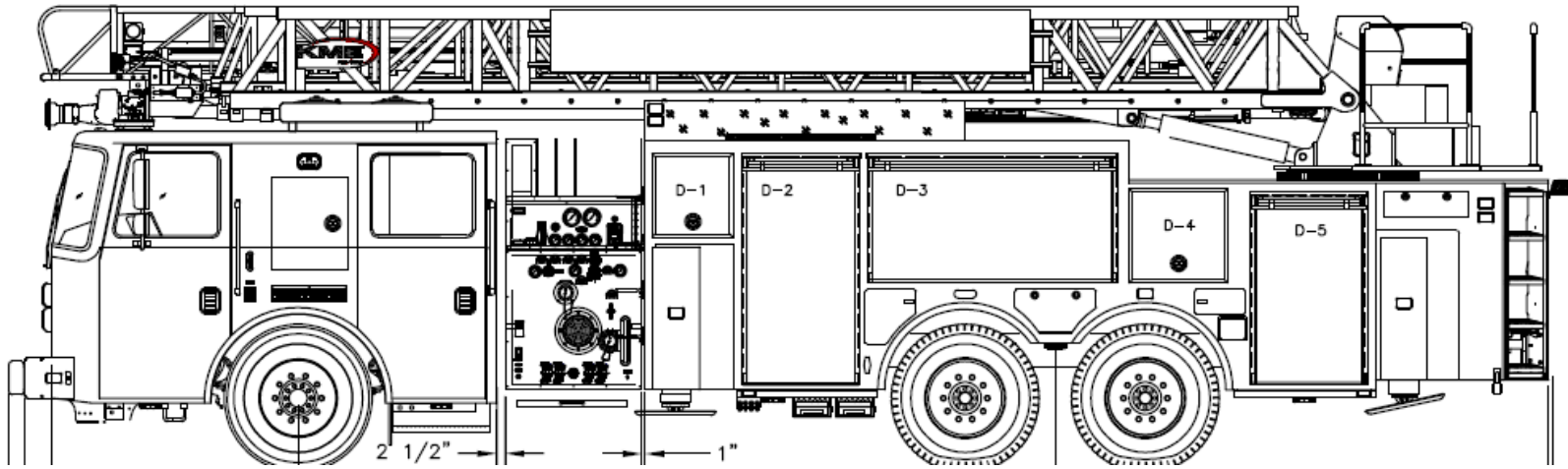

ORANGE COUNTY, CA SEVERE SERVICE TUFF TRUCK

Truck # 11606



CHASSIS

- 100" KME Severe Service XMFD with a flat roof
- Cummins® X15 engine, 605HP; Allison® 4500 EVSR transmission
- Valor seating for (5) firefighters
- 110,000 PSI triple frame rail
- Hendrickson STEERTEK™ 22,000-pound front axle and suspension
- Hendrickson FIREMAAX® EX 54,000-pound air ride tandem rear suspension
- EMS compartments built in cab with exterior access
- 138" overall height
- 38' 7" overall length
- 227" wheelbase

BODY FEATURES

- (20) SCBA cylinder compartments in fender area
- 3/16" aluminum body
- Dual turntable access ladders
- Roof-top storage compartments
- Center hose bed storage chute

AERIAL FEATURES

- 103' 4-section aerial ladder
- 500lb tip load unrestricted
- 12' jack stance fully extended
- IQAN safety system
- Akron StreamMaster™ monitor

ELECTRIC & WARNING

- Code 3 warning light system
- HiViz® LED scene lights
- Harrison® 8KW hydraulic generator
- Hannay Reels® 240-volt cord reel
- Class 1 Es-Key Multiplex System

PUMP & PLUMBING

- HALE® DSD 1500 GPM single stage pump
- 300-gallon water tank

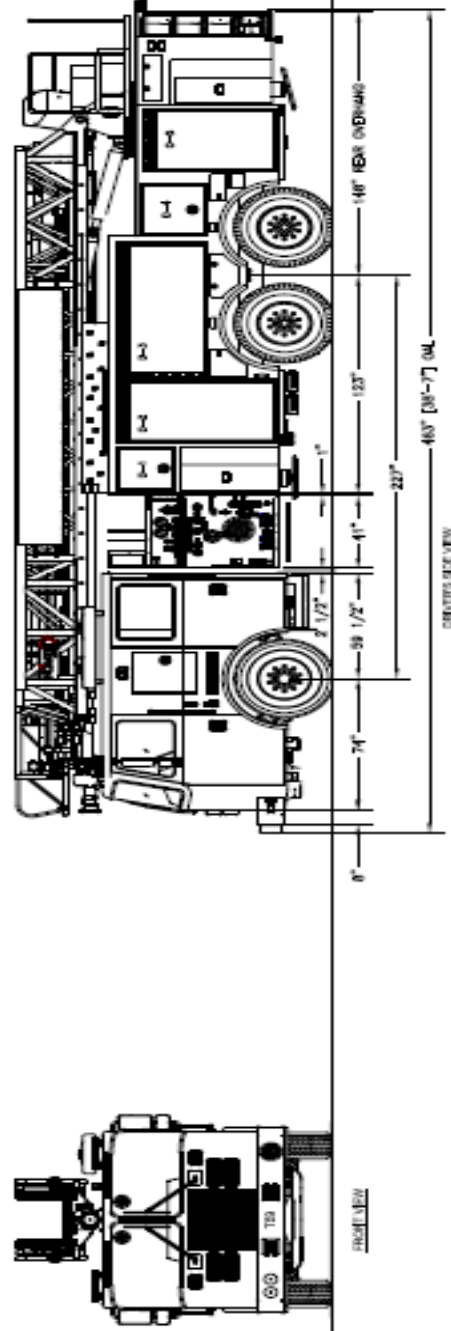
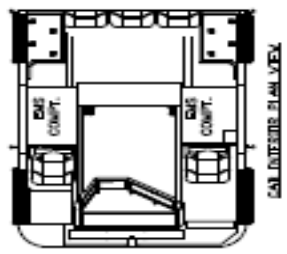
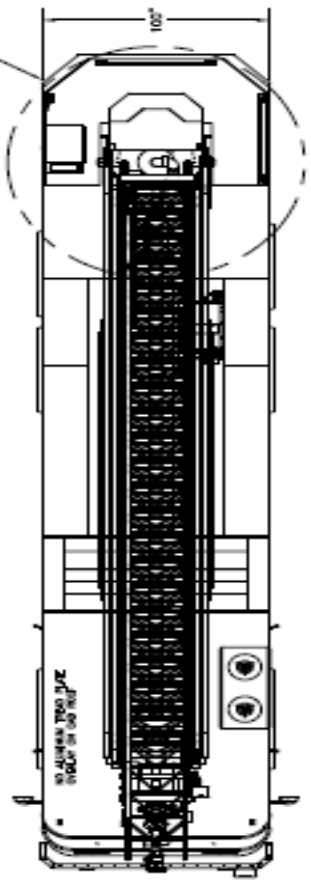
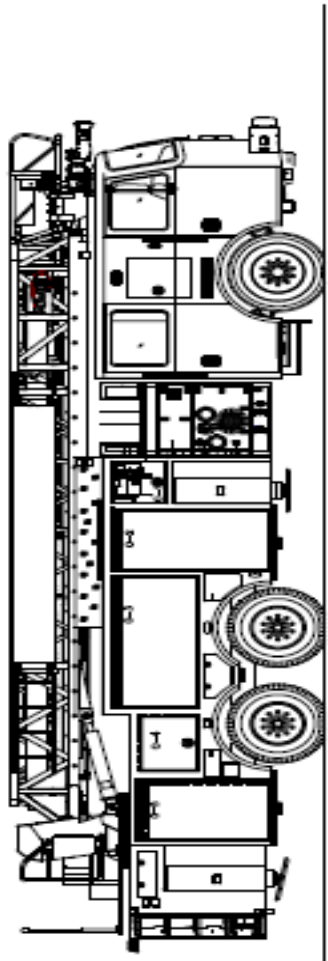
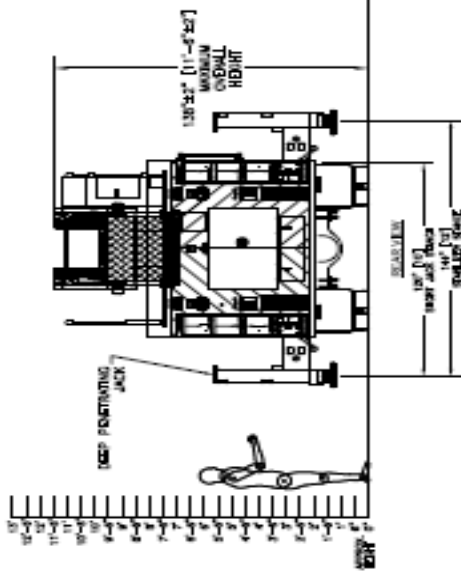

CAB: PRECATOR SERVICE 3007 X-MPD FLAT FLOOR
 ENGINE/TRANSMISSION: XIS 602 HP / Allison 4500EVR
 AXIAL SERVICE: 110 REAR MOUNT LADDER
 PUMP: HALF DSD 1200 GPM SINGLE STAGE
 TANK TYPE: 300 GALLON POLYURE
 BODY: 5014 ALUMINUM

ITEM	DESCRIPTION	QTY	UNIT
C	1771204	1	PC-1
D	3274322	1	PC-1
A	3274322	1	PC-1
UN	3274322	1	PC-1
PC-1	3274322	1	PC-1

DATE: 10/15/2014 10:15 AM
 DRAWN BY: J. J. JONES
 CHECKED BY: J. J. JONES
 3007 REAR MOUNT LADDER
 ORANGE COUNTY, CA
 GSO #11606-11608 & 11663





SANTA MONICA, CA

SEVERE SERVICE PUMPER

Truck # 11696

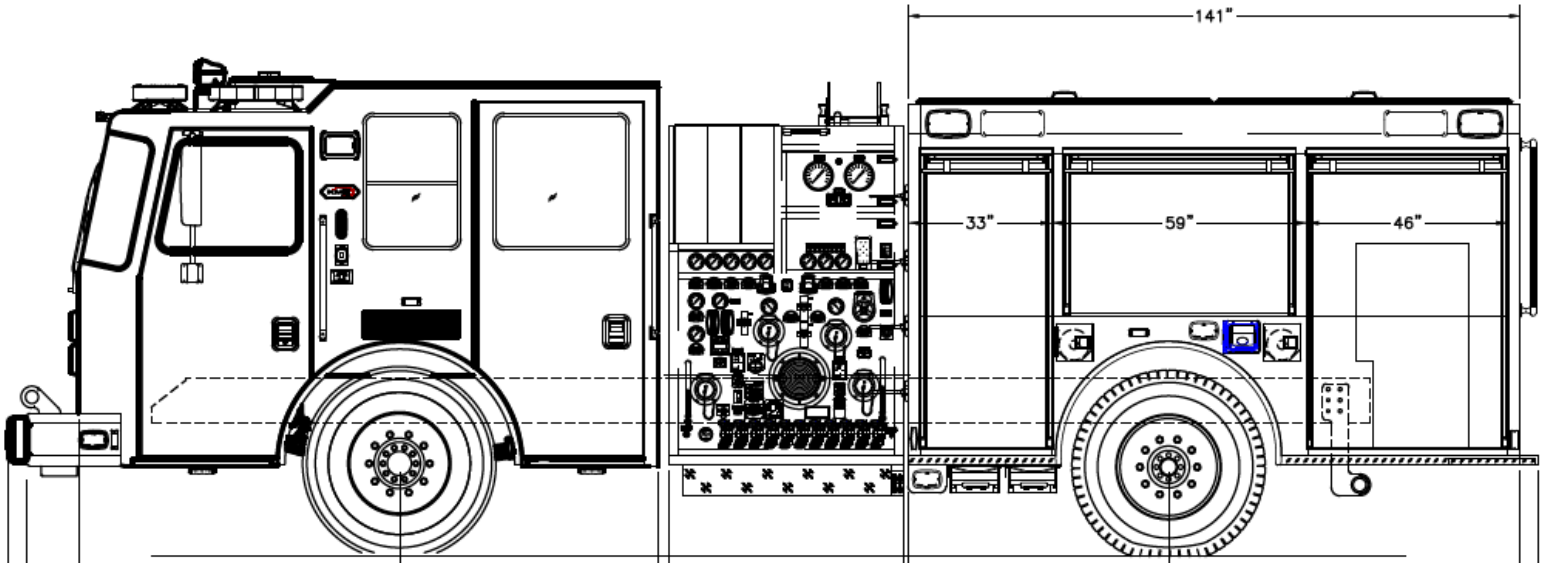

CHASSIS

- 96" wide KME Severe Service XMFD with 6" raised roof
- Cummins® X12 engine, 500HP; Allison® 4000 EVS transmission
- Valor seating for (7) firefighters
- 110,000 PSI double frame rail
- Hendrickson STEERTEK® 22,000-pound front axle and suspension
- Hendrickson FIREMAAX® 24,000-pound air ride rear suspension
- 120" overall height
- 29' 4" overall length
- 177" wheelbase

BODY FEATURES

- (4) SCBA cylinder compartments in fender area
- 100" wide FLEX 12 GA galvanized steel body
- Zico single arm ladder rack officer side
- Rom painted roll-up doors
- Roof top compartments

ELECTRIC & WARNING

- Whelen® warning light system
- HiViz® brow light
- FRC® Spectra body scene lights
- Class 1 Es-Key multiplex system

PUMP & PLUMBING

- HALE® QMAX 1500 GPM single-stage pump
- 500-gallon water tank
- 40 & 10-gallon foam tank
- FoamPro® 2002 Foam system

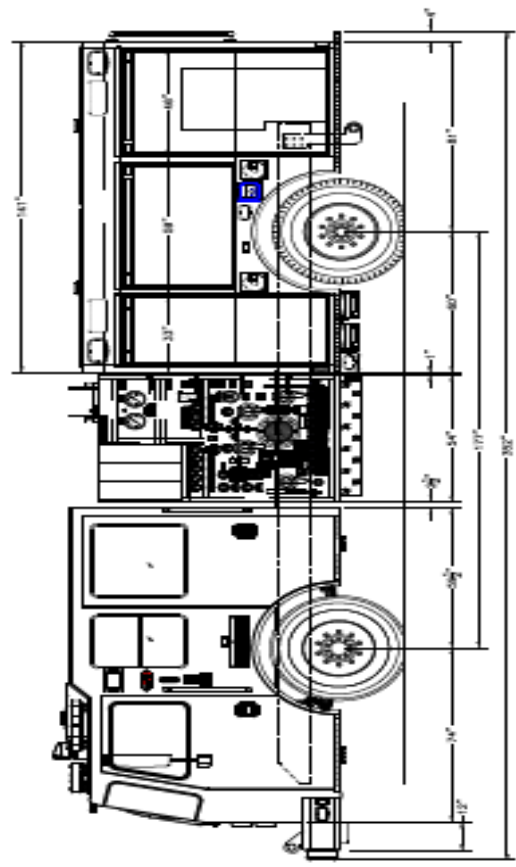
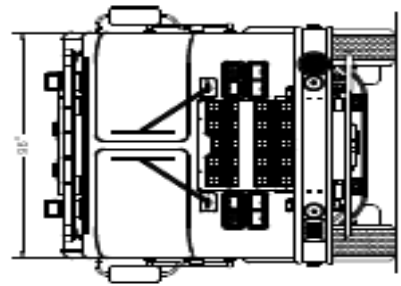
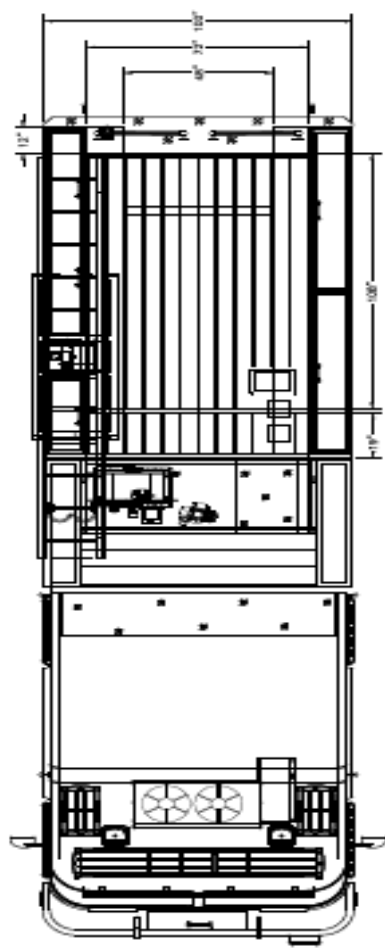
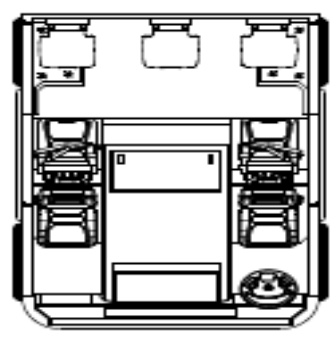
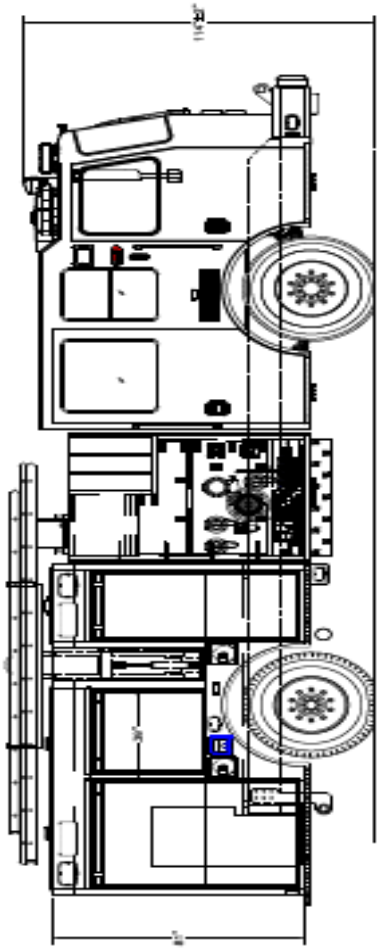
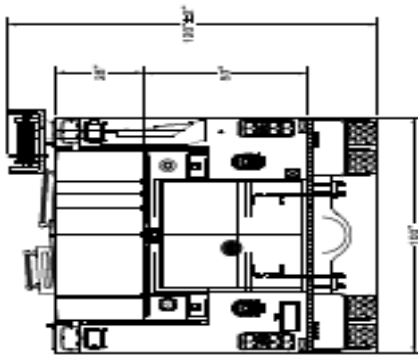
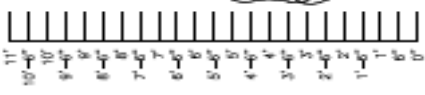

CAB: 96"W KME SEVERE SERVICE X-MFD 6" RR ALUM
 ENGINE & TRANS: CUMMINS X12 500 HP/ALLISON 4000EVS
 AXLES: 22,000# STEERTEK FRONT/24,000# REAR
 PUMP: HALE QMAX-150 1500 GPM SINGLE STAGE
 WATER TANK: 500 GALLONS POLY W/40/10 GALLON FOAM
 BODY TYPE: 141" FLAT BACK 12 GA GALV
 FOAM SYSTEM: FOAM PRO 2002

SEE DRAWINGS 2-A THROUGH
 2-C FOR DIMENSIONS AND 3-D FOR
 DIMENSIONS. DIMENSIONS ARE
 APPROXIMATE. DIMENSIONS ARE
 SUBJECT TO CHANGE WITHOUT
 NOTICE. CONTACT APPROXIMATE REAL
 PERSONS FOR DIMENSIONS.

CUSTOMER APPROVAL:
 NAME: _____
 TITLE: _____
 DATE: _____

REV	DATE	DESCRIPTION	APP'D
1	10/20/12	REVISED AS PER DIMENSIONS FOR CONFLICTS	MS
2	10/20/12	REVISED AS PER DIMENSIONS FOR CONFLICTS	MS
3	10/20/12	REVISED AS PER DIMENSIONS FOR CONFLICTS	MS
4	10/20/12	REVISED AS PER DIMENSIONS FOR CONFLICTS	MS
5	10/20/12	REVISED AS PER DIMENSIONS FOR CONFLICTS	MS
6	10/20/12	REVISED AS PER DIMENSIONS FOR CONFLICTS	MS
7	10/20/12	REVISED AS PER DIMENSIONS FOR CONFLICTS	MS
8	10/20/12	REVISED AS PER DIMENSIONS FOR CONFLICTS	MS
9	10/20/12	REVISED AS PER DIMENSIONS FOR CONFLICTS	MS
10	10/20/12	REVISED AS PER DIMENSIONS FOR CONFLICTS	MS
11	10/20/12	REVISED AS PER DIMENSIONS FOR CONFLICTS	MS
12	10/20/12	REVISED AS PER DIMENSIONS FOR CONFLICTS	MS
13	10/20/12	REVISED AS PER DIMENSIONS FOR CONFLICTS	MS
14	10/20/12	REVISED AS PER DIMENSIONS FOR CONFLICTS	MS
15	10/20/12	REVISED AS PER DIMENSIONS FOR CONFLICTS	MS
16	10/20/12	REVISED AS PER DIMENSIONS FOR CONFLICTS	MS
17	10/20/12	REVISED AS PER DIMENSIONS FOR CONFLICTS	MS
18	10/20/12	REVISED AS PER DIMENSIONS FOR CONFLICTS	MS
19	10/20/12	REVISED AS PER DIMENSIONS FOR CONFLICTS	MS
20	10/20/12	REVISED AS PER DIMENSIONS FOR CONFLICTS	MS
21	10/20/12	REVISED AS PER DIMENSIONS FOR CONFLICTS	MS
22	10/20/12	REVISED AS PER DIMENSIONS FOR CONFLICTS	MS
23	10/20/12	REVISED AS PER DIMENSIONS FOR CONFLICTS	MS
24	10/20/12	REVISED AS PER DIMENSIONS FOR CONFLICTS	MS
25	10/20/12	REVISED AS PER DIMENSIONS FOR CONFLICTS	MS
26	10/20/12	REVISED AS PER DIMENSIONS FOR CONFLICTS	MS
27	10/20/12	REVISED AS PER DIMENSIONS FOR CONFLICTS	MS
28	10/20/12	REVISED AS PER DIMENSIONS FOR CONFLICTS	MS
29	10/20/12	REVISED AS PER DIMENSIONS FOR CONFLICTS	MS
30	10/20/12	REVISED AS PER DIMENSIONS FOR CONFLICTS	MS
31	10/20/12	REVISED AS PER DIMENSIONS FOR CONFLICTS	MS
32	10/20/12	REVISED AS PER DIMENSIONS FOR CONFLICTS	MS
33	10/20/12	REVISED AS PER DIMENSIONS FOR CONFLICTS	MS
34	10/20/12	REVISED AS PER DIMENSIONS FOR CONFLICTS	MS
35	10/20/12	REVISED AS PER DIMENSIONS FOR CONFLICTS	MS
36	10/20/12	REVISED AS PER DIMENSIONS FOR CONFLICTS	MS
37	10/20/12	REVISED AS PER DIMENSIONS FOR CONFLICTS	MS
38	10/20/12	REVISED AS PER DIMENSIONS FOR CONFLICTS	MS
39	10/20/12	REVISED AS PER DIMENSIONS FOR CONFLICTS	MS
40	10/20/12	REVISED AS PER DIMENSIONS FOR CONFLICTS	MS
41	10/20/12	REVISED AS PER DIMENSIONS FOR CONFLICTS	MS
42	10/20/12	REVISED AS PER DIMENSIONS FOR CONFLICTS	MS
43	10/20/12	REVISED AS PER DIMENSIONS FOR CONFLICTS	MS
44	10/20/12	REVISED AS PER DIMENSIONS FOR CONFLICTS	MS
45	10/20/12	REVISED AS PER DIMENSIONS FOR CONFLICTS	MS
46	10/20/12	REVISED AS PER DIMENSIONS FOR CONFLICTS	MS
47	10/20/12	REVISED AS PER DIMENSIONS FOR CONFLICTS	MS
48	10/20/12	REVISED AS PER DIMENSIONS FOR CONFLICTS	MS
49	10/20/12	REVISED AS PER DIMENSIONS FOR CONFLICTS	MS
50	10/20/12	REVISED AS PER DIMENSIONS FOR CONFLICTS	MS
51	10/20/12	REVISED AS PER DIMENSIONS FOR CONFLICTS	MS
52	10/20/12	REVISED AS PER DIMENSIONS FOR CONFLICTS	MS
53	10/20/12	REVISED AS PER DIMENSIONS FOR CONFLICTS	MS
54	10/20/12	REVISED AS PER DIMENSIONS FOR CONFLICTS	MS
55	10/20/12	REVISED AS PER DIMENSIONS FOR CONFLICTS	MS
56	10/20/12	REVISED AS PER DIMENSIONS FOR CONFLICTS	MS
57	10/20/12	REVISED AS PER DIMENSIONS FOR CONFLICTS	MS
58	10/20/12	REVISED AS PER DIMENSIONS FOR CONFLICTS	MS
59	10/20/12	REVISED AS PER DIMENSIONS FOR CONFLICTS	MS
60	10/20/12	REVISED AS PER DIMENSIONS FOR CONFLICTS	MS
61	10/20/12	REVISED AS PER DIMENSIONS FOR CONFLICTS	MS
62	10/20/12	REVISED AS PER DIMENSIONS FOR CONFLICTS	MS
63	10/20/12	REVISED AS PER DIMENSIONS FOR CONFLICTS	MS
64	10/20/12	REVISED AS PER DIMENSIONS FOR CONFLICTS	MS
65	10/20/12	REVISED AS PER DIMENSIONS FOR CONFLICTS	MS
66	10/20/12	REVISED AS PER DIMENSIONS FOR CONFLICTS	MS
67	10/20/12	REVISED AS PER DIMENSIONS FOR CONFLICTS	MS
68	10/20/12	REVISED AS PER DIMENSIONS FOR CONFLICTS	MS
69	10/20/12	REVISED AS PER DIMENSIONS FOR CONFLICTS	MS
70	10/20/12	REVISED AS PER DIMENSIONS FOR CONFLICTS	MS
71	10/20/12	REVISED AS PER DIMENSIONS FOR CONFLICTS	MS
72	10/20/12	REVISED AS PER DIMENSIONS FOR CONFLICTS	MS
73	10/20/12	REVISED AS PER DIMENSIONS FOR CONFLICTS	MS
74	10/20/12	REVISED AS PER DIMENSIONS FOR CONFLICTS	MS
75	10/20/12	REVISED AS PER DIMENSIONS FOR CONFLICTS	MS
76	10/20/12	REVISED AS PER DIMENSIONS FOR CONFLICTS	MS
77	10/20/12	REVISED AS PER DIMENSIONS FOR CONFLICTS	MS
78	10/20/12	REVISED AS PER DIMENSIONS FOR CONFLICTS	MS
79	10/20/12	REVISED AS PER DIMENSIONS FOR CONFLICTS	MS
80	10/20/12	REVISED AS PER DIMENSIONS FOR CONFLICTS	MS
81	10/20/12	REVISED AS PER DIMENSIONS FOR CONFLICTS	MS
82	10/20/12	REVISED AS PER DIMENSIONS FOR CONFLICTS	MS
83	10/20/12	REVISED AS PER DIMENSIONS FOR CONFLICTS	MS
84	10/20/12	REVISED AS PER DIMENSIONS FOR CONFLICTS	MS
85	10/20/12	REVISED AS PER DIMENSIONS FOR CONFLICTS	MS
86	10/20/12	REVISED AS PER DIMENSIONS FOR CONFLICTS	MS
87	10/20/12	REVISED AS PER DIMENSIONS FOR CONFLICTS	MS
88	10/20/12	REVISED AS PER DIMENSIONS FOR CONFLICTS	MS
89	10/20/12	REVISED AS PER DIMENSIONS FOR CONFLICTS	MS
90	10/20/12	REVISED AS PER DIMENSIONS FOR CONFLICTS	MS
91	10/20/12	REVISED AS PER DIMENSIONS FOR CONFLICTS	MS
92	10/20/12	REVISED AS PER DIMENSIONS FOR CONFLICTS	MS
93	10/20/12	REVISED AS PER DIMENSIONS FOR CONFLICTS	MS
94	10/20/12	REVISED AS PER DIMENSIONS FOR CONFLICTS	MS
95	10/20/12	REVISED AS PER DIMENSIONS FOR CONFLICTS	MS
96	10/20/12	REVISED AS PER DIMENSIONS FOR CONFLICTS	MS
97	10/20/12	REVISED AS PER DIMENSIONS FOR CONFLICTS	MS
98	10/20/12	REVISED AS PER DIMENSIONS FOR CONFLICTS	MS
99	10/20/12	REVISED AS PER DIMENSIONS FOR CONFLICTS	MS
100	10/20/12	REVISED AS PER DIMENSIONS FOR CONFLICTS	MS

DESIGNED BY: APPROVED BY: DATE: 10/20/12
 TRUCK TYPE: APPROVED BY: DATE: 10/20/12
 DRAWN BY: APPROVED BY: DATE: 10/20/12
 KME CUSTOM PUMPER
 SANTA MONICA, CA
 GSO# 11569-570





FRANCESTOWN, NH

SEVERE SERVICE PUMPER

Truck # 11759

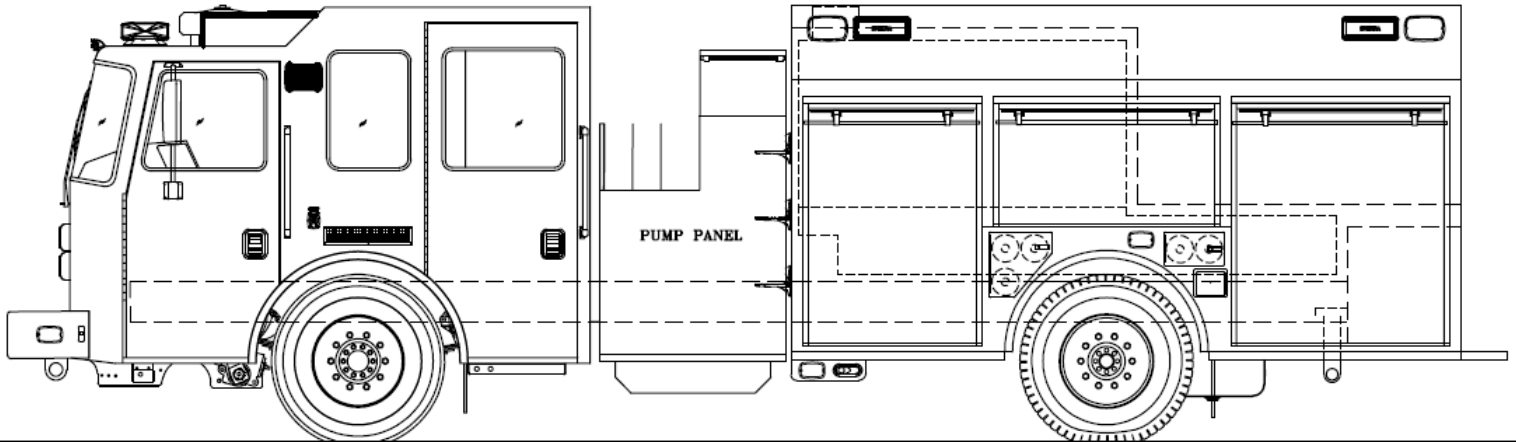

CHASSIS

- 100" Wide KME Severe Service XMFD with 10" raised roof
- Cummins® X12 engine, 500HP; Allison® 4000 EVS transmission
- Valor seating for (6) firefighters
- 110,000 PSI galvanized single frame rail
- Hendrickson STEERTEK® 22,000-pound front axle and suspension
- Hendrickson FIREMAAX® EX 27,000-pound air ride rear suspension
- 112" overall height
- 32' 1" overall length
- 192" wheelbase

BODY FEATURES

- (11) SCBA cylinder compartments in fender area
- FLEX extruded aluminum body
- Ladder and suction hose storage tunnel on apparatus rear next to water tank
- ROM roll-up doors
- Lowered hosebed design

ELECTRIC & WARNING

- Federal Signal® warning light system
- FRC® brow and scene system
- Control-Maxx™ electrical system

PUMP & PLUMBING

- Waterous® CSU 1500 GPM single-stage pump
- Lowered crosslays
- Future foam system provisions
- 1,000-gallon L water tank
- 20-gallon foam tank

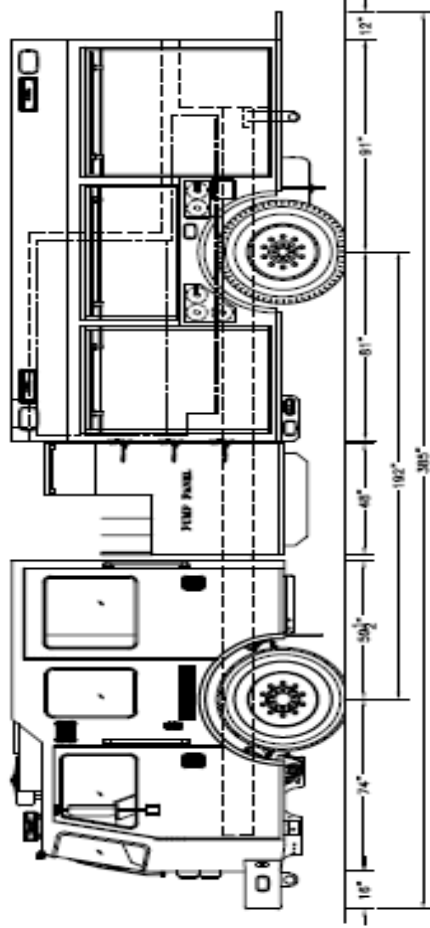
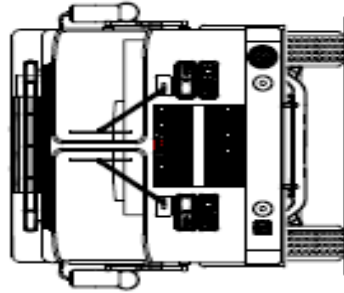
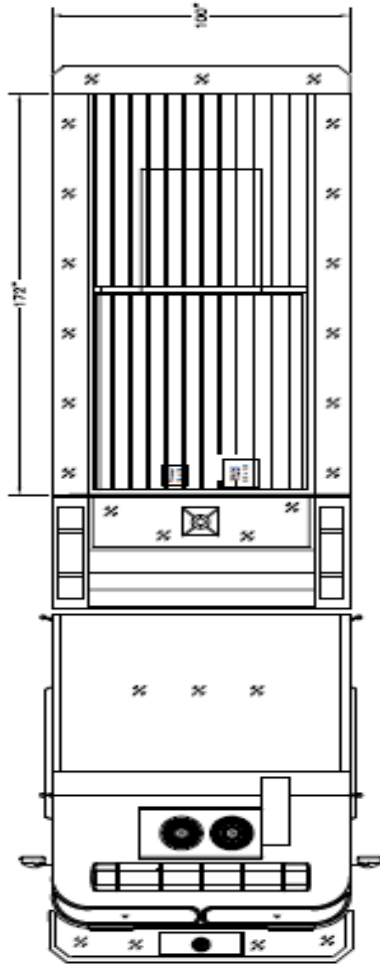
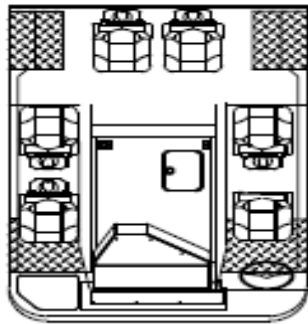
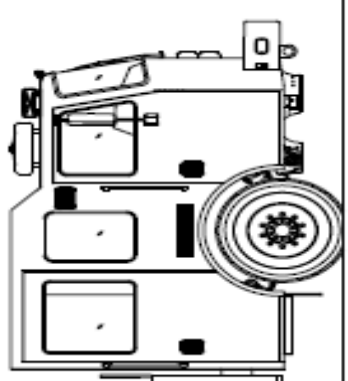
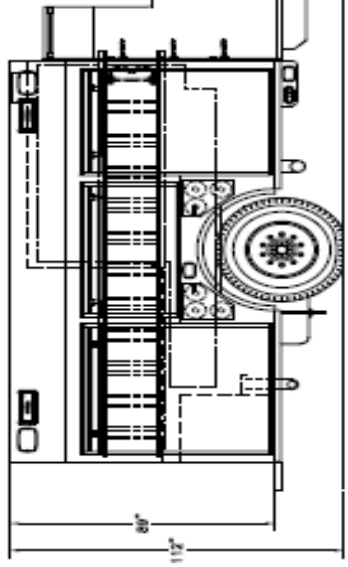
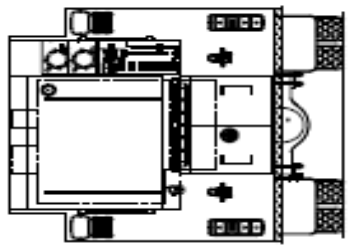
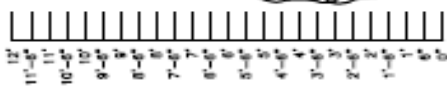

CAB: 100" W SEVERE SERVICE VMFD 10" BR ALUM
 ENGINE & TRNS: CUMMINS X12 500 HP/ALLISON 4000 EVS
 AXLES: 22,000# STERTEK FRONT/27,000# REAR
 PUMP: WATEROUS CSJ-C22-1500 GPM SINGLE STAGE
 WATER TANK: 1,000 GALLONS POLY W/20 GALLONS FOAM
 BODY TYPE: 172" FLEX PUMPER 3/16" ALUMINUM

THIS DRAWING IS A GENERAL
 REPRESENTATION AND MAY NOT
 BE USED FOR CONSTRUCTION
 WITHOUT THE SIGNATURE OF THE
 CONTRACT ENGINEER. SEE
 CONTRACT FOR OTHER DETAILS.

CUSTOMER APPROVAL:
 NAME: _____
 TITLE: _____
 DATE: _____

DESIGNER AND APPROVER: S. MARY MARY INC. (BY TITLE) ALL RIGHTS RESERVED
 SCALE: FIVE EIGHTS (5/8) INCH = 1 FOOT
 DATE: 11/15/2008
 DRAWN BY: KME PUMPER
 CHECKED BY: BULLDOG FIRE APPARATUS, MA
 SALES ENGINEER: TONY MAF

